

CrushGrind Shaft Mini - 100mm

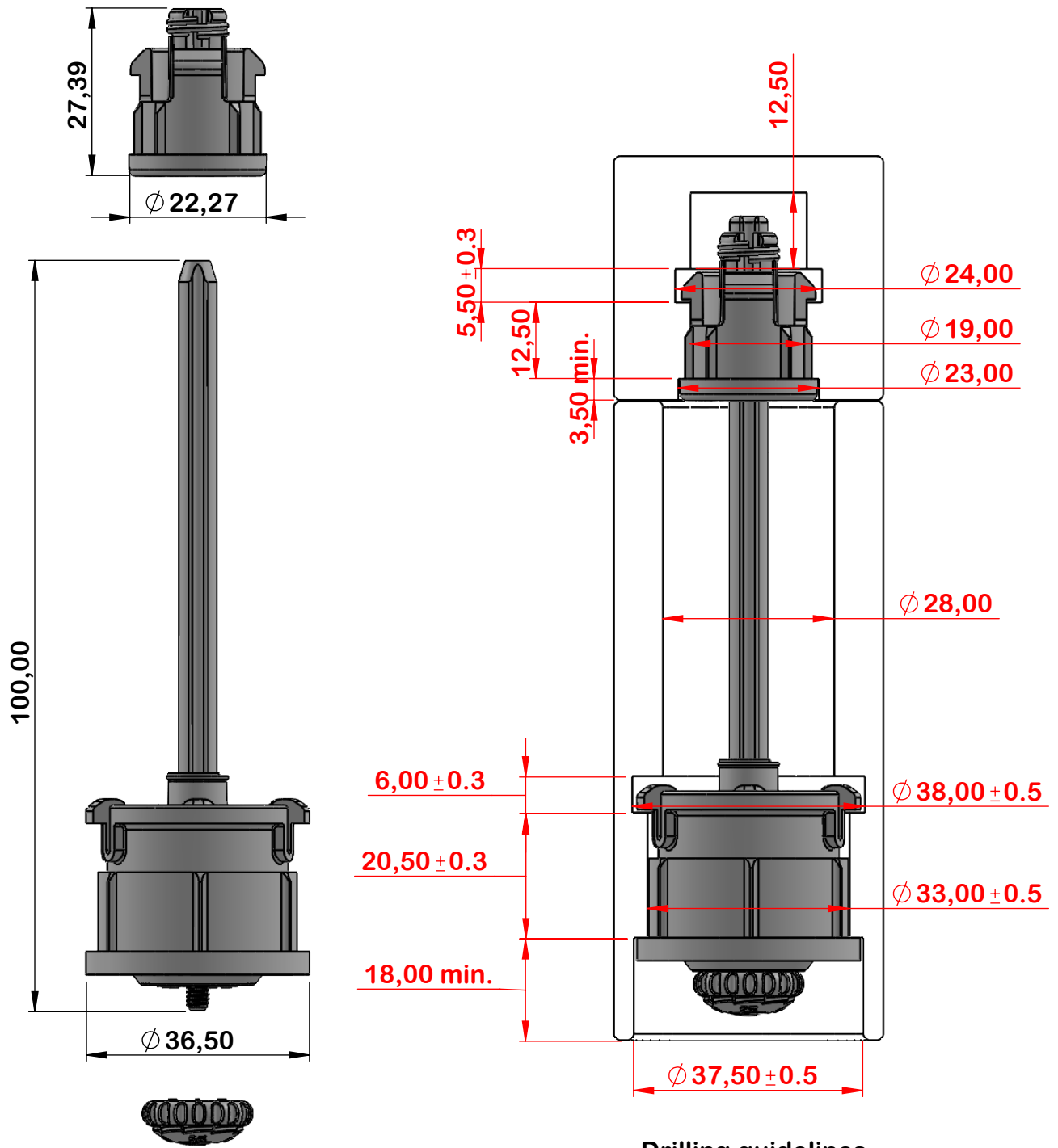

Drilling guidelines